

## TWH-N - HYDRAULIC TORQUE WRENCH - DRIVE CYLINDERS



Working pressure 700 Bar

Powerful with low clearance design

Fitted with 360° x 360° Uni-Swivel couplings

Hi-Force TWH-N series female hexagon cassette head hydraulic torque wrenches offer a choice of 5 models with output torque capacities from 2625 Nm to 48181 Nm (1906 to 34985 lbf.ft). Manufactured from high grade aluminium (except TWH430N), all models provide direct in-line reaction and a minimal radius clearance for easy fitment in confined spaces. The user friendly design of the tool simply requires the operator to withdraw/insert a single pin to change the ratchet head. Ratchet heads are available in all standard metric and imperial AF sizes from 24 to 175mm (1 1/16" to 6 7/8") with low cost hexagon reducer bushes also available (see pages 84 - 85). Uni-Swivel quick release couplers are fitted as standard to all models, enabling easy positioning of the hydraulic hoses.

- >> Compact, lightweight, aluminium drive unit (except TWH430N)
- >> Accurate to +/- 3% with standard torque chart supplied
- >> Low profile design for limited access applications
- >> Minimum radius cassette head for fitment in confined spaces
- >> Suitable for continuous operation at maximum pressure



**Note:** Model TWH430N manufactured from high grade alloy steel

## TWH-N - HYDRAULIC TORQUE WRENCH - DRIVE CYLINDERS

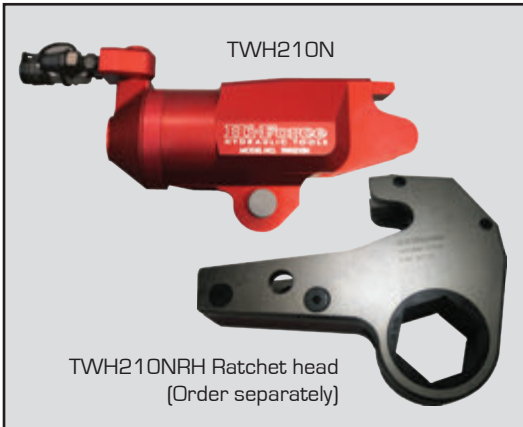

Designed for tightening and loosening applications

Easily assembled to selected ratchet head

Minimal nose radius for fitment in confined spaces

TWH27N, TWH54N,  
TWH120N, TWH210N

TWH430N

All Models

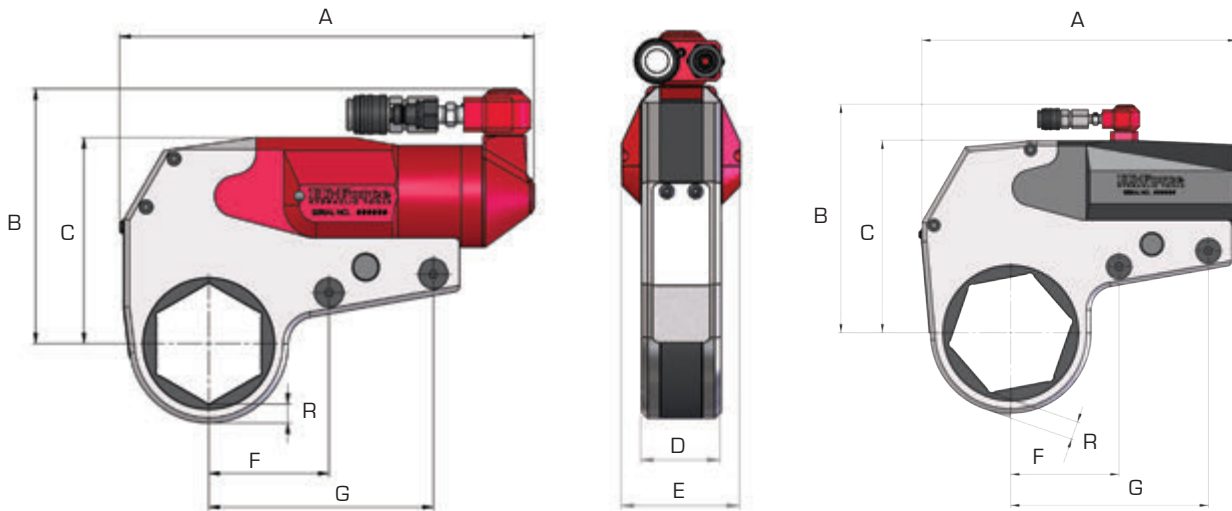

**Note:** Drawing shows drive cylinder, including ratchet head as detailed on pages 81 - 82.  
Drive cylinder and ratchet head are separate items and must be ordered separately.

Model number (drive cyl.)	Torque capacity		Hexagon AF size		Weight kg	Dimensions in mm							
	Nm at 700 Bar	lbf. ft at 10,000PSI	Metric min	Imperial max		A max	B max	C max	D	E	F	G	R min - max
<b>TWH27N</b>	2625	1906	24 to 46	1 1/16" to 1 3/16"	1.4	193	125	97	32	51	54	109	9.5 - 12.2
	3068	2228	50 to 60	2" to 2 3/8"	1.4	193	136	108	32	51	54	109	10.1 - 10.5
<b>TWH54N</b>	5372	3901	38 to 65	1 7/16" to 2 1/16"	2.3	250	158	125	41	64	73	137	10.7 - 13.8
	6037	4384	70 to 80	2 3/4" to 3 1/8"	2.3	250	169	136	41	64	73	137	11.7 - 14.6
<b>TWH120N</b>	11737	8522	50 to 80	2 3/16" to 3 1/8"	3.8	310	189	157	52	78	92	112	14.7 - 15.2
	14349	10419	85 to 100	3 1/2" to 3 7/8"	3.8	310	214	182	52	78	92	112	15.9 - 18.7
<b>TWH210N</b>	21216	15405	70 to 100	2 3/4" to 3 7/8"	6.4	378	223	191	64	97	114	213	18.1 - 18.6
	23124	16791	105 to 115	4 1/4" to 4 5/8"	6.4	378	236	204	64	97	114	213	18.3 - 20.7
<b>TWH430N</b>	43792	31798	80 to 115	3 1/8" to 4 5/8"	16.1	405	291	242	83	93	146	267	25.6 - 31.3
	48181	34985	130 to 175	5" to 6 7/8"	16.1	425	309	260	83	93	146	267	24.8 - 27.3

**Note:** Above selection table is for drive unit only. Ratchet head(s) to be ordered separately - see pages 81 - 82.  
Weight as stated is drive cylinder only, exact radius size (R) varies according to ratchet AF size selected.